

# 1000€

## User's Manual

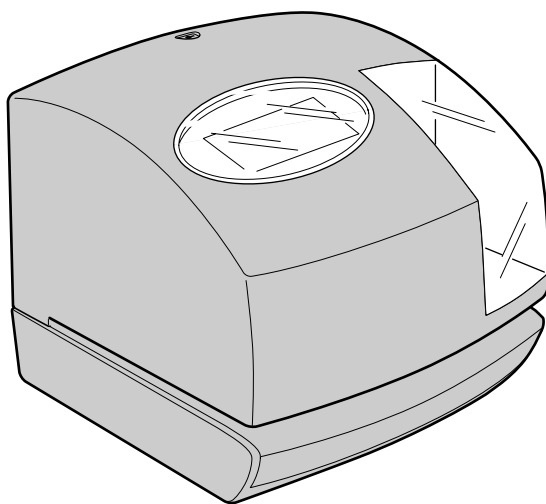

Lathem Time Corporation

## WARNING

This equipment has been tested and found to comply with the limits for a Class A digital device, pursuant to Part 15 of FCC Rules. These limits are designed to provide reasonable protection against harmful interference when the equipment is operated in a commercial environment. This equipment generates, uses, and can radiate radio frequency energy and, if not installed and used in accordance with the instruction manual, may cause harmful interference to radio communications. Operation of this equipment in a residential area is likely to cause harmful interference in which case the user will be required to correct the interference at his or her own expense.

**Caution:** Changes or modifications not expressly approved by the party responsible for compliance could void the user's authority to operate the equipment.

THIS DIGITAL APPARATUS DOES NOT EXCEED THE CLASS A LIMITS FOR RADIO NOISE EMISSIONS FROM DIGITAL APPARATUS AS SET OUT IN THE RADIO INTERFERENCE REGULATIONS OF THE CANADIAN DEPARTMENT OF COMMUNICATIONS.

LE PRÉSENT APPAREIL NUMÉRIQUE N'ÉMET PAS DE BRUITS RADIOÉLECTRIQUES DÉPASSANT LES LIMITES APPLICABLES AUX APPAREILS NUMÉRIQUES DE CLASSE A PRESCRITES DANS LE RÈGLEMENT SUR LE BROUILLAGE RADIOÉLECTRIQUE ÉDICTÉ PAR LE MINISTÈRE DES COMMUNICATIONS DU CANADA.

1. The details of this User's Manual are subject to change even without previous notification.
2. This User's Manual has been prepared with the utmost care to cover all aspects of the time clock's use.
3. Be sure to use your time clock after you have fully understood the hardware and software specifications and limits.
4. No part of this publication may be reproduced, stored in a retrieval system, or transmitted, in any form or by any means, mechanical, photocopying, recording or otherwise.

This User's Manual and its contents are copyrighted by LATHEM TIME CORP. with all rights reserved.



**Lathem Time Corporation**

[www.lathem.com](http://www.lathem.com)

(800) 241-4990

Thank you for purchasing our time clock.

For safe and proper operation, please carefully read the manual before using the time clock and save it for reference.

## Features:

Main applications: Payroll/job cost recorder or time stamp

- Quartz time clock
  - Dot matrix printer
  - Perpetual calendar
  - Automatic daylight saving time
  - 3-way print activation
    - Automatic
    - Semi-automatic
    - Manual
  - Prints in 4 languages
- 12 or 24-hour format
  - Regular minute, 1/10, 1/60, 1/100 or 5/100 of an hour
  - 2 or 4-digit year imprint
  - 13 preprogramed comments
  - Digital LCD display (Date, Hour, Minute, Day of the week indication)
  - Adjustable print position
  - Prints seconds

## Caution:

Avoid placing the unit in environments that are:

- humid or dusty.
- exposed to direct sunshine.
- subject to frequent or continuous vibrations.
- outside the temperature range between -5° and 45°C  
(+25° and 113°F)
- affected by chemicals or ozone.

Place the time clock close to the wall outlet so that it is easily accessible to disconnect.

Do not put a heavy object on the clock, or not forcefully press the cover of the clock. It may cause mechanism trouble and danger especially when the unit is hung on the wall.

Replace battery with TOSHIBA, part no. CR 2450 TVB only. Use of another battery may present a risk of fire or explosion.

**For questions about the operation of this time clock, or to order supplies and accessories, please contact Lathem Time at (800)241-4990.**

# BEFORE USING THE TIME CLOCK

## Accessories

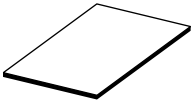

User's manual



Key

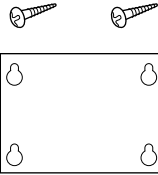

Wall-mount fittings  
Screws (2 pcs.)  
Template

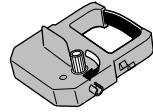

Ribbon cassette  
(installed at the factory)

## Configuration

### <Front view>

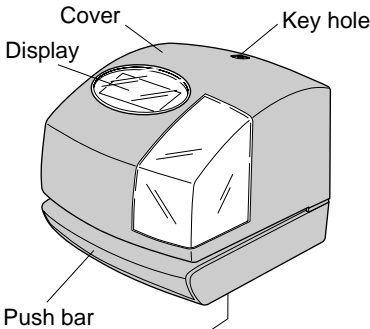

### <Cover off>

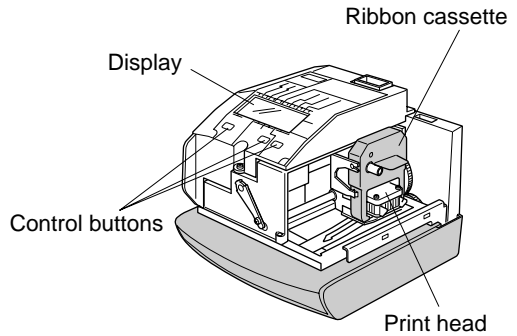

### <Back view>

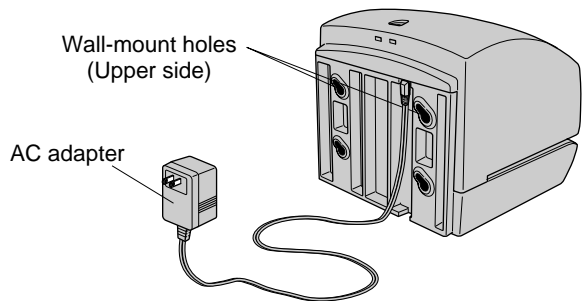

### <Print position adjuster>

The print position from the card edge is adjustable by pressing and sliding the print position button on outside bottom.

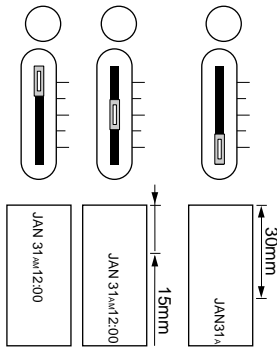

### PRINT POSITION ON TIME CARD

The print position from the card edge is adjustable by pressing and sliding the print position button located on the right outside bottom of the recorder. Maximum distance from edge of form to print is approximately 1 3/16"(30mm).

# QUICK EASY SETUP

NOTICE: Remove the **PROTECTION PAD** before you plug the AC adapter into the AC outlet.

To setup your time clock, follow next steps:

## Step 1

Unlock the key and remove the cover.

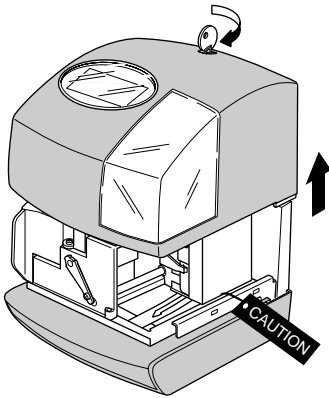

## Step 2

Remove the **PROTECTION PAD**, and plug the AC adapter into the time clock.

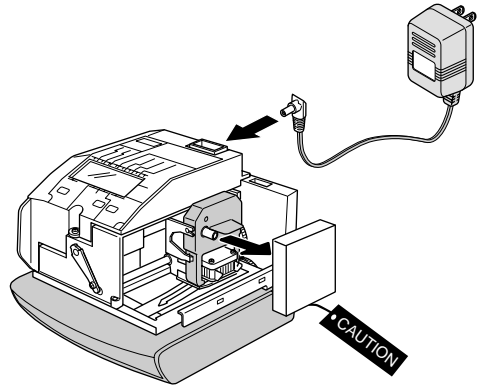

## Step 3

Replace the cover and lock.

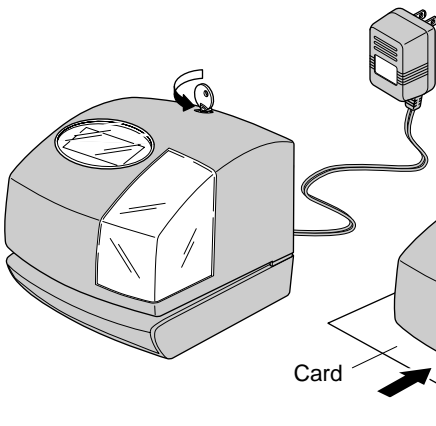

## Step 4

Plug the AC adapter into the AC outlet and insert a card.

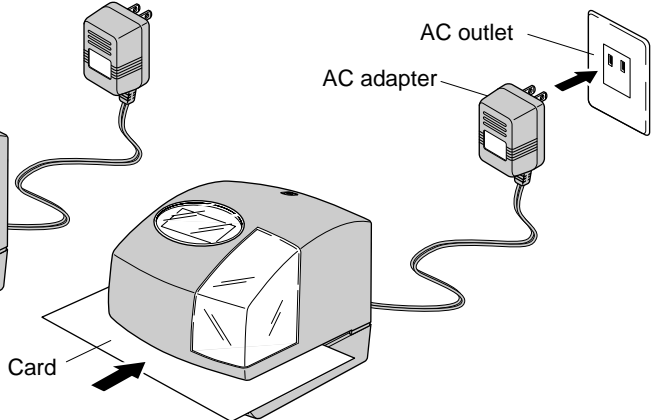

# HOW TO PROGRAM THE CLOCK

To enter the program setting mode, you should plug the AC adapter into the AC outlet and remove the cover. Thereafter press the **SELECT** button once. Then the clock goes into the program mode showing the "▲" on the display positioned at the "TIME".

**L.C.D.**

'AA BB-CC

Reference  
for programming

**PRINT ORDER**

Y=Year  
M=Month  
D=Date  
DOW=Day of the week  
H=Hour  
Min=Minute  
S=Second  
C=Comment

1. M.D.H.Min	10. M.D
2. D.M.H.Min	11. DOW.D.M.Y
3. M.D.Y.H.Min	12. C.M.D.Y
4. D.M.Y.H.Min	13. C.D.M.Y
5. Y.M.D.H.Min	14. C.Y.M.D
6. Y.M.D.H.Min.S	15. M.D.Y.C
7. D.H.Min	16. D.M.Y.C
8. DOW.D.H.Min	17. Y.M.D.C
9. Y.M.D	18. C.D.H.Min

**DISPLAY**

AA:Sec. | AA:Year | 1.12hour  
 BB:Hour | BB:Month | 2.24hour  
 CC:Min. | CC:Date

**PRINT STYLE**

1.2Digits	BB:Hour	1.ZERO	1.RCVD
2.4Digits	1.12hour	Disabled	2.SENT
	2.24hour	2.ZERO	3.IN
		Enabled	4.OUT
CC:Minute			5.CFMD
1.1/60			6.FILED
2.1/100			7.PAID
3.1/20			8.USED
4.1/10			9.FAXED
			10.VOID
			11.ORIGN
			12.APR'D
			13.CMPL'D

TIME	DATE	HOUR	PRINT ORDER	YEAR DIGIT	HOUR MIN.	LEADING ZERO	COMMENT
▲	▲	▲	▲	▲	▲	▲	▲
▲	▲	▲	▲	▲	▲	▲	▲
▲	▲	▲	▲	▲	▲	▲	▲

**LANGUAGE**

1.ENGLISH  
2.FRENCH  
3.SPANISH  
4.PORTUGUESE

**PRINT DIRECTION PRINT ACTIVATION**

BB:Print Direction  
1.Right  
2.Left

CC:Print Activation  
1.Automatic  
2.Semi-automatic  
3.Manual

**CONTROL BUTTONS:** **SELECT**, **CHANGE**, **SET**

**Control buttons**

**Program modes**

## Function of 3 control buttons

**SELECT** : You can select the desired program setting mode by pressing this **SELECT** button. Selected program setting mode is indicated by the "▲" mark on the display.

**CHANGE** : When you press the **CHANGE** button, you can increment the set value.

**SET** : You can set the value selected on the display by pressing the **SET** button. Thereafter you press this **SET** button again, you can return the clock to the normal operation mode.

# SETTING THE DISPLAY FORMAT

## SETTING THE TIME

Example: Change the time from 10:08 to 10:09.

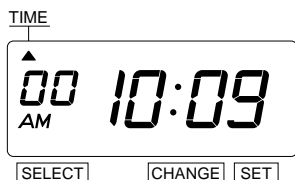
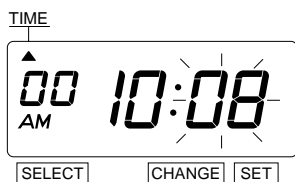
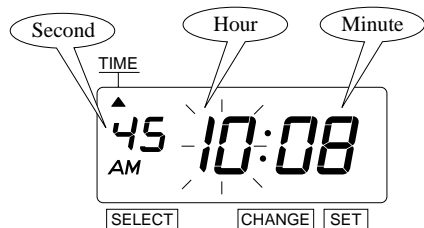

### Step 1

Press the **SELECT** button and position the "▲" mark at the "TIME".

At that moment, the "Hour" flashes. (The flashing means it can be changed.)

#### Change the "Hour".

In case of the example, press the **SET** button because the hour is not to be changed.

At that moment, the flashing changes from "Hour" to "Minute".

### Step 2

#### Change the "Minute".

Press the **CHANGE** button to set at "09", and then press the **SET** button.

At that moment, the "Second" starts to run from "00".

### Step 3

After you finish setting the time, press the **SET** button once again.

Now the time setting has been completed. Replace the cover and lock.

**IMPORTANT:** If you do not complete Step 3, the clock will not print.

# SETTING THE DATE

Example: Change the date from October 20, 2001 to October 21, 2001.

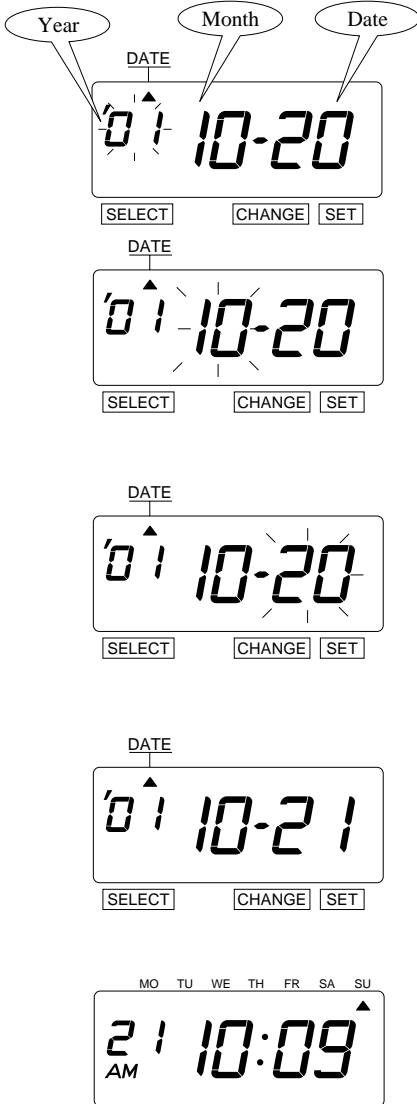

## Step 1

Press the **SELECT** button and position the "▲" mark at the "DATE".

At that moment, the "Year" flashes. (The flashing means it can be changed.)

### Change the "Year".

In case of the example, press the **SET** button because the year 2001 is not to be changed.

At that moment, the flashing changes from "Year" to "Month".

## Step 2

### Change the "Month".

In case of the example, press the **SET** button because the month is not to be changed.

At that moment, the flashing changes from "Month" to "Date".

## Step 3

### Change the "Date".

Press the **CHANGE** button to set at "21", and then press the **SET** button.

## Step 4

After you finish setting the date, press the **SET** button once again.

Now the date setting has been completed. Replace the cover and lock.

**IMPORTANT:** If you do not complete Step 4, the clock will not print.



# SETTING THE 12/24 HOUR

Example: Change the hour format to 24 hour.

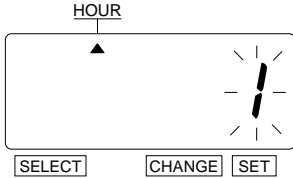

## Step 1

Press the **SELECT** button and position the "▲" mark at the "HOUR".  
At that moment, the flashing digit indicates "Order Options" of the hour format. (The flashing means it can be changed.)

	Order Options	Display
1.	12 hour	PM 3:00
2.	24 hour	15:00

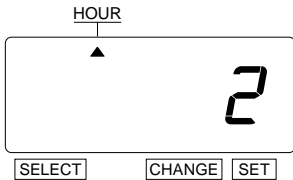

In case of the example, press the **CHANGE** button to set at "2". And then press the **SET** button.

## Step 2

After you finish setting the 12/ 24 hour, press the **SET** button once again.  
Now the 12/24 hour setting has been completed. Replace the cover and lock.



**IMPORTANT:** If you do not complete Step 2, the clock will not print.

# SETTING THE PRINT ORDER

Example: Change the print order to "Month, Date, Year, Hour, Minute".

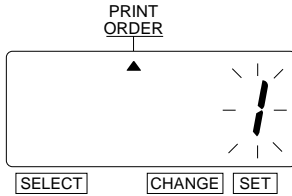

## Step 1

Press the **SELECT** button and position the "▲" mark at the "PRINT ORDER".

At that moment, the flashing digits indicate "Order Options" of the print order. (The flashing means it can be changed.)

Y=Year, M=Month, D=Date, DOW=Day of the week, H=Hour, Min=Minute  
S=Second, C=Comment

	Order Option	Print Example
1.	M, D, H, Min	JAN 31 AM10:00
2.	D, M, H, Min	31 JAN AM10:00
3.	M, D, Y, H, Min	JAN 31 '01 AM10:00
4.	D, M, Y, H, Min	31 JAN '01 AM10:00
5.	Y, M, D, H, Min	'01 JAN 31 AM10:00
6.	Y, M, D, H, Min, S	'01 JAN 31 AM 10:00:00
7.	D, H, Min	31 AM10:00
8.	DOW, D, H, Min	WE, 31 AM10:00
9.	Y, M, D	'01 JAN 31
10.	M, D	JAN 31
11.	DOW, D, M, Y	WE, 31 JAN '01
12.	C, M, D, Y	SENT JAN 31 '01
13.	C, D, M, Y	SENT 31 JAN '01
14.	C, Y, M, D	SENT '01 JAN 31
15.	M, D, Y, C	JAN 31 '01 SENT
16.	D, M, Y, C	31 JAN '01 SENT
17.	Y, M, D, C	'01 JAN 31 SENT
18.	C, D, H, Min	SENT 31 AM10:00

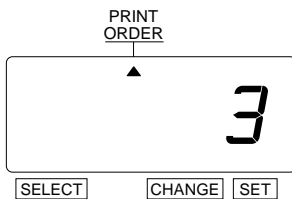

In case of the example, press the **CHANGE** button to set at "3". And then press the **SET** button.

## Step 2

After you finish setting the print order, press the **SET** button once again.

Now the print order setting has been completed. Replace the cover and lock.



**IMPORTANT:** If you do not complete Step 2, the clock will not print.

# SETTING THE PRINT STYLE

## SETTING THE YEAR DIGIT

Example: Change the year imprint to 4 digits.

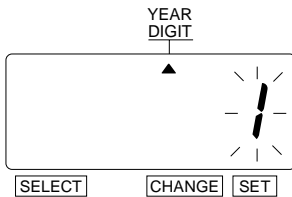

### Step 1

Press the **SELECT** button and position the "▲" mark at the "YEAR DIGIT".

At that moment, the flashing digit indicates "Order Options" of the year imprint. (The flashing means it can be changed.)

	Order Options	Print Example
1.	2 Digits	JAN 31 '01 AM10:00
2.	4 Digits	JAN 31 2001 AM10:00

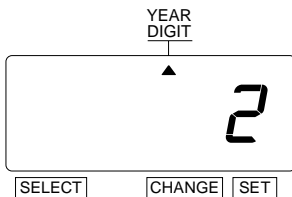

In case of the example, press the **CHANGE** button to set at "2", and then press the **SET** button.

### Step 2

After you finish setting the year digit, press the **SET** button once again.

Now the year digit setting has been completed. Replace the cover and lock.

**IMPORTANT:** If you do not complete Step 2, the clock will not print.



# SETTING THE HOUR/MIN.

Example: Change the print style of the "Hour" and "Minute" to 24 hour and 1/100 min.

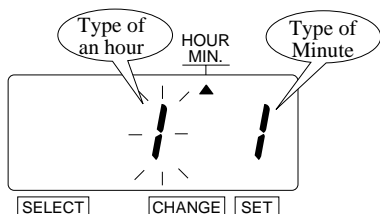

## Step 1

Press the **SELECT** button and position the "▲" mark at the "HOUR /MIN".

At that moment, the flashing digit at the left indicates "Order Options" of the print style of the "Hour". (The flashing means it can be changed.)

### Change the "Hour".

	Order Options	Print Example
1.	12 Hour	JAN 31 PM3:00
2.	24 Hour	JAN 31 15:00

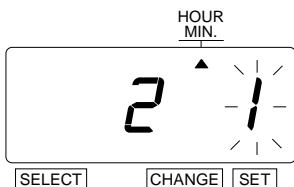

In case of the example, press the **CHANGE** button to set at "2". And then press the **SET** button.

At that moment, the flashing changes from "Hour" to "Minute".

## Step 2

### Change the "Minute".

	Order Options	Print Example		Order Options	Print Example
1.	1/60 Min.	JAN 31 AM12:10	3.	1/20 Min. (=5/100 Min.)	JAN 31 AM12.15
2.	1/100 Min.	JAN 31 AM12.17	4.	1/10 Min.	JAN 31 AM12.1

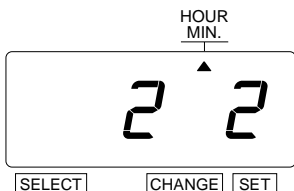

In case of the example, press the **CHANGE** button to set at "2". And then press the **SET** button.

## Step 3

After you finish setting the hour/minute, press the **SET** button once again.

Now the hour/minute setting has been completed. Replace the cover and lock.



**IMPORTANT:** If you do not complete Step 3, the clock will not print.

# SETTING THE LEADING ZERO

Example: Change the leading zero to "ZERO: Disabled".

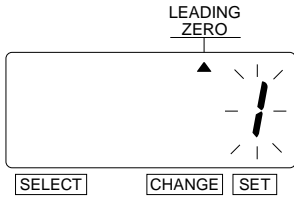

## Step 1

Press the **SELECT** button and position the "▲" mark at the "LEADING ZERO". At that moment, the flashing digit indicates "Order Options" of the leading zero.

(The flashing means it can be changed.)

	Order Options	Print Example
1.	ZERO Disabled	JAN 1 PM3:00
2.	ZERO Enabled	JAN 01 PM03:00

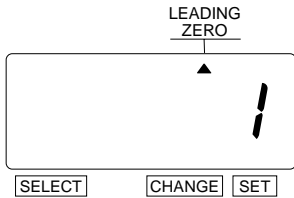

In case of the example, press the **CHANGE** button to set at "1". And then press the **SET** button.



## Step 2

After you finish setting the leading zero, press the **SET** button once again. Now the leading zero setting has been completed. Replace the cover and lock.

**IMPORTANT:** If you do not complete Step 2, the clock will not print.

# SETTING THE COMMENT

Example: Change the comment to "SENT".

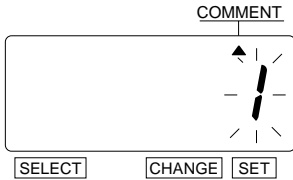

## Step 1

Press the **SELECT** button and position the "▲" mark at the "COMMENT".  
 At that moment, the flashing digits indicate "Order Options" of the comment.  
 (The flashing means it can be changed.)

	Order Options	Print Example
1.	RCVD	JAN 31 '01 RCVD
2.	SENT	JAN 31 '01 SENT
3.	IN	JAN 31 '01 IN
4.	OUT	JAN 31 '01 OUT
5.	CFMD	JAN 31 '01 CFMD
6.	FILED	JAN 31 '01 FILED
7.	PAID	JAN 31 '01 PAID
8.	USED	JAN 31 '01 USED
9.	FAXED	JAN 31 '01 FAXED
10.	VOID	JAN 31 '01 VOID
11.	ORIGN	JAN 31 '01 ORIGN
12.	APR'D	JAN 31 '01 APR'D
13.	CMPL'D	JAN 31 '01 CMPL'D

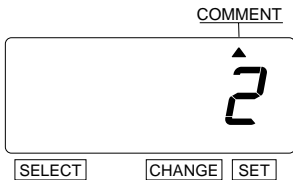

In case of the example, press the **CHANGE** button to set at "2". And then press the **SET** button.

## Step 2

After you finish setting the comment, press the **SET** button once again.  
 Now the comment setting has been completed. Replace the cover and lock.



**IMPORTANT:** If you do not complete Step 2, the clock will not print.

# SETTING THE LANGUAGE

This setting is available if you select "Month," "Day of the week" or "Comment" in previous "PRINT ORDER".

Example: Change the print language into French.

## Step 1

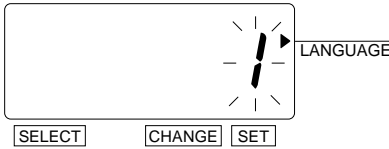

Press the **SELECT** button and position the "▲" mark at the "LANGUAGE".

At that moment, the flashing digit indicates "Order Options" of the print language. (The flashing means it can be changed.)

	Order Options	Print Example
1.	ENGLISH	WE, 26 DEC '01 OUT 31 AM10:00
2.	FRENCH	ME, 26 DEC '01 SORT 31 AM10:00
3.	SPANISH	MI, 26 DIC '01 SAL 31 AM10:00
4.	PORTUGUESE	QA, 26 DEZ '01 SAIDA 31 AM10:00

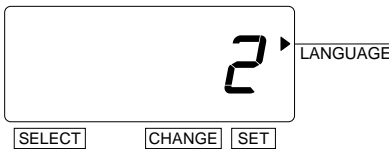

In case of the example, press the **CHANGE** button to set at "2". And then press the **SET** button.

## Step 2

After you finish setting the language, press the **SET** button once again.

Now the language setting has been completed. Replace the cover and lock.



**IMPORTANT:** If you do not complete Step 2, the clock will not print.

# SETTING THE PRINT METHOD

Example: Change the print direction to "Left" and the print activation to "Manual".

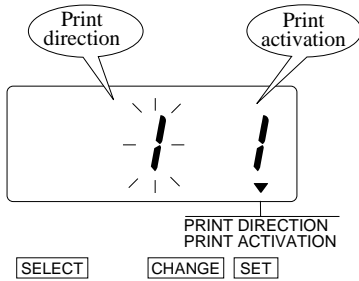

## Step 1

Press the **SELECT** button and position the "▲" mark at the "PRINT DIRECTION; PRINT ACTIVATION".

At that moment, the flashing digit at the left indicates "Order Options" of the print direction. (The flashing means it can be changed.)

### Change the "Print Direction".

	Order Options
1.	Right
2.	Left

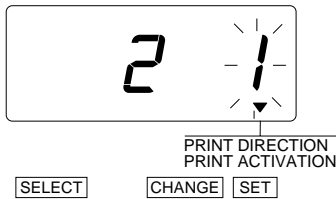

In case of the example, press the **CHANGE** button to set at "2". And then press the **SET** button.

At that moment, the flashing changes from the "Print Direction" to the "Print Activation".



## Step 2

### Change the "Print Activation".

	Order Options
1.	Automatic
2.	Semi-automatic
3.	Manual

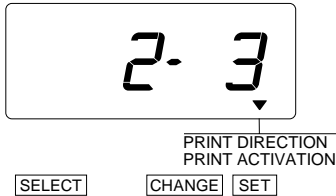

In case of the example, press the **CHANGE** button to set at "3". And then press the **SET** button.



## Step 3

After you finish setting the print method, press the **SET** button once again. Now the print method setting has been completed. Replace the cover and lock.

**IMPORTANT:** If you do not complete Step 3, the clock will not print.

**Automatic** will allow the clock to print by simply inserting a card or sheet of paper.

**Semi-automatic** will allow the clock to print by pressing the push bar only when a card or piece of paper is inserted.

**Manual** will allow the clock to print by pressing the push bar.

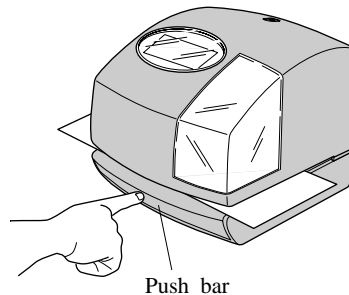

# SETTING THE DAYLIGHT SAVING TIME

Example: Start date Sunday, March 25, 2001.

End date Sunday, October 28, 2001.

If you set as the above, the time clock remembers the start date as the last Sunday of March and the end date as the last Sunday of October. Once set, the time clock automatically updates the settings every year thereafter. No further manual setting is necessary.

## SETTING THE STARTING DATE OF DAYLIGHT SAVING TIME

Example: Daylight saving time starts on Sunday, March 25, 2001.

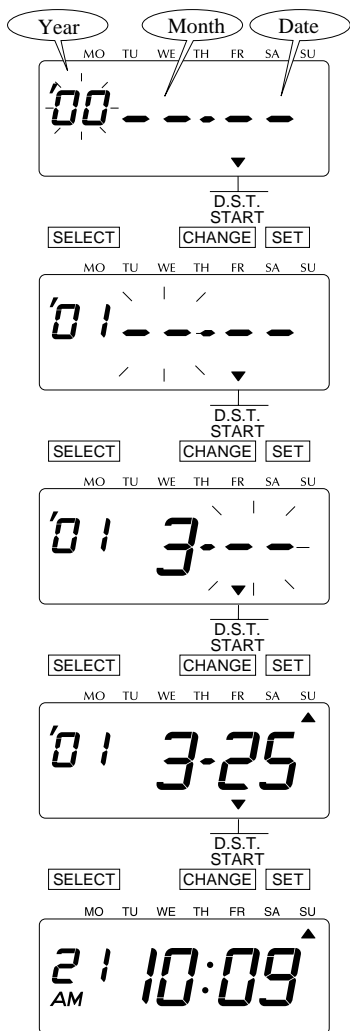

### Step 1

Press the **SELECT** button and position the "▲" mark at the "D.S.T. START". At that moment, the "Year" flashes. (The flashing means it can be changed.)

#### Change the "Year".

In case of the example, press the **CHANGE** button to set at "01". And then press the **SET** button.

At that moment, the flashing changes from "Year" to "Month".

### Step 2

#### Change the "Month".

Press the **CHANGE** button to set at "3". And then press the **SET** button.

At that moment, the flashing changes from "Month" to "Date".

### Step 3

#### Change the "Date".

Press the **CHANGE** button to set at "25". And then press the **SET** button.

### Step 4

After you finish setting the starting date of D.S.T., press the **SET** button once again. Now the starting date of D.S.T. setting has been completed.

**Go on to the "SETTING THE ENDING DATE OF DAYLIGHT SAVING TIME".**

# SETTING THE ENDING DATE OF DAYLIGHT SAVING TIME

Example: Daylight saving time ends on Sunday, October 28, 2001.

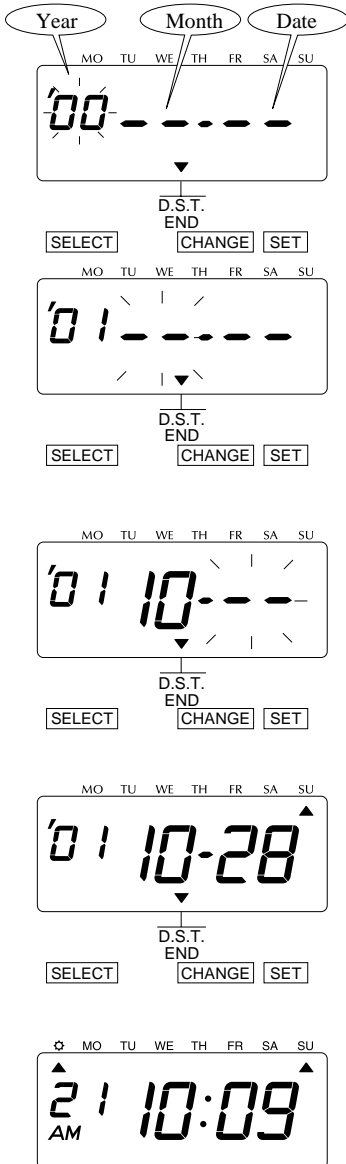

## Step 1

Press the **SELECT** button and position the "▲" mark at the "D.S.T. END".

At that moment, the "Year" flashes. (The flashing means it can be changed.)

### Change the "Year".

In case of the example, press the **CHANGE** button to set at "01". And then press the **SET** button.

At that moment, the flashing changes from "Year" to "Month".

## Step 2

### Change the "Month".

Press the **CHANGE** button to set at "10". And then press the **SET** button.

At that moment, the flashing changes from "Month" to "Date".

## Step 3

### Change the "Date".

Press the **CHANGE** button to set at "28". And then press the **SET** button.

## Step 4

After you finish setting the ending date of D.S.T., press the **SET** button once again. Now the ending date of D.S.T. setting has been completed. Replace the cover and lock.

**IMPORTANT:** If you do not complete Step 4, the clock will not print.

# DELETING THE DAYLIGHT SAVING TIME SETTING

To delete and cancel the daylight saving time setting, change the display of "Month" of the starting setting to " - - - ".

Example: Change March 25, 2001 of "D.S.T. START" and delete daylight saving time setting.

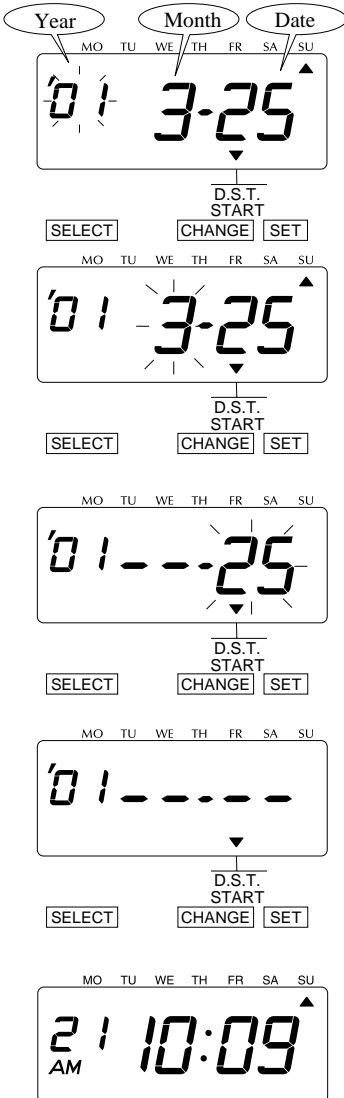

## Step 1

Press the **SELECT** button and position the "▲" mark at the "D.S.T. START". At that moment, the "Year" flashes. (The flashing means it can be changed.)

Next, press the **SET** button. At that moment, the flashing changes from "Year" to "Month".

## Step 2

Press the **CHANGE** button to set at " - - - ". And then press the **SET** button. At that moment, the flashing changes from "Month" to "Date".

## Step 3

Press the **SET** button again. At that moment, the flashing changes from "25" to " - - - ".

## Step 4

Press the **SET** button once again. Now the D.S.T. deleting has been completed. Replace the cover and lock.

**IMPORTANT:** If you do not complete Step 4, the clock will not print.

# SETTING THE PASSWORD

When the password is set, you are asked to enter it. If the password you entered does not coincide with the setting, you cannot change the setting values.

You may set a password by any 4-digit number from 0001 to 9998.

Note a number "0000" and "9999" cannot be used as a password.

## REGISTERING THE PASSWORD

Example: Set the password "1234".



PASSWORD  
SELECT CHANGE SET

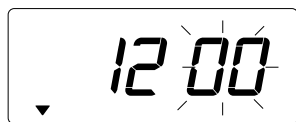

PASSWORD  
SELECT CHANGE SET

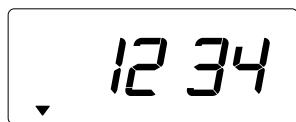

PASSWORD  
SELECT CHANGE SET



### Step 1

Press the **SELECT** button and position the "▲" mark at the "PASSWORD".

At that moment, first two digits flash. (The flashing means it can be changed.)

In case of the example, press the **CHANGE** button to set at "12". And then press the **SET** button.

At that moment, the flashing changes to last two digits.

### Step 2

In case of the example, press the **CHANGE** button to set at "34". And then press the **SET** button.

### Step 3

After you finish registering the password, press the **SET** button once again.

Now the password registering has been completed. Replace the cover and lock.

**IMPORTANT:** If you do not complete Step 3, the clock will not print.

# HOW TO CHANGE SETTING WHEN THE PASSWORD IS SET

Once the password is set, you have to enter the password for changing any setting. "99 99" will be displayed when you press the **SELECT** button before entering.

Example: Password "1234".

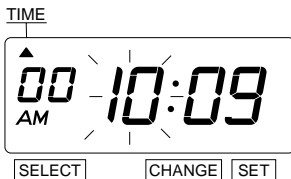
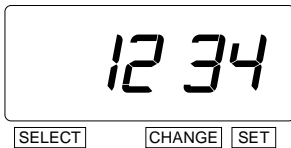
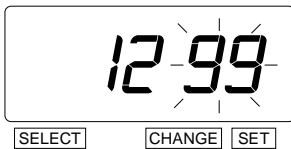
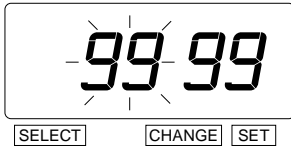

## Step 1

Press the **SELECT** button, at that moment "99 99" is displayed and first two digits flashes. (The flashing means it can be changed.)

In the example, press the **CHANGE** button to set at "12". And then press the **SET** button.

At that moment, the flashing changes to last two digits.

## Step 2

In case of the example, press the **CHANGE** button to set at "34". And then press the **SET** button.

At that moment, the "▲" mark indicates the "TIME".

## Step 3

Select desired setting mode by pressing the **SELECT** button.

Then make settings as explained.

# CANCELING THE PASSWORD

The code "00 00" must be entered to cancel the password.

Example: Cancel the password "1234".

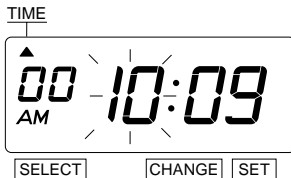
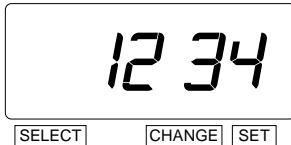
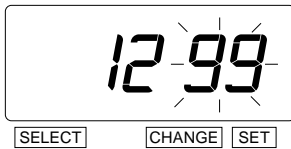
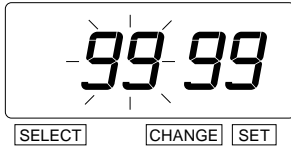

## Step 1

Press the **SELECT** button, at that moment "99 99" is displayed and first two digits flashes. (The flashing means it can be changed.)

In case of the example, press the **CHANGE** button to set at "12". And then press the **SET** button.

At that moment, the flashing changes to last two digits.

## Step 2

In case of the example, press the **CHANGE** button to set at "34". And then press the **SET** button.

At that moment, the "▲" mark indicates the "TIME".



PASSWORD  
SELECT CHANGE SET



PASSWORD  
SELECT CHANGE SET



PASSWORD  
SELECT CHANGE SET



### Step 3

Press the **SELECT** button and position the "▲" mark at the "PASSWORD".

At that moment, first two digits "12" flashes. (The flashing means it can be changed.)

Press the **CHANGE** button to set at "00". And then press the **SET** button.

At that moment, the flashing changes to last two digits "34".

### Step 4

Press the **CHANGE** button to set at "00". And then press the **SET** button.

### Step 5

After you finish canceling the password, press the **SET** button once again. Now the password canceling has been completed. Replace the cover and lock.

**IMPORTANT:** If you do not complete Step 5, the clock will not print.



# RESETTING

To return all setting to the factory defaults, push the reset switch with a pointed implement.

**NOTICE:** All your custom settings will be deleted and will revert to the factory defaults when the reset switch is pushed. To make new settings, please refer to "SETTING".

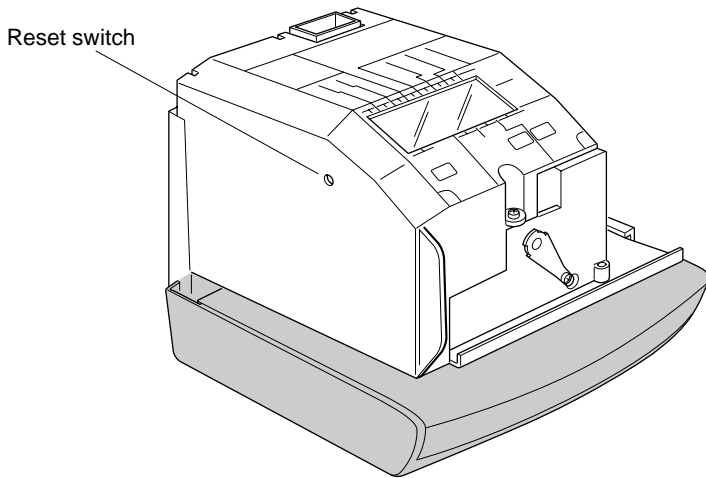

# WALL MOUNTING

Caution: The supplied screws are intended for use on a thick wooden wall or wooden column. Do not use them on any other materials. The time clock may come off if used on other materials.

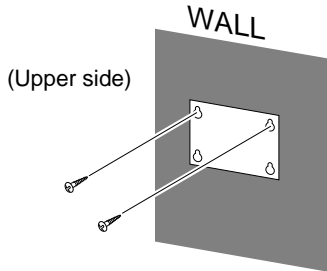

## Step 1

Install the supplied wall-mount screws into a wall by using the template, 9 cm by 5 cm apart. Be sure to keep about 6 mm of the screw head away from the wall.

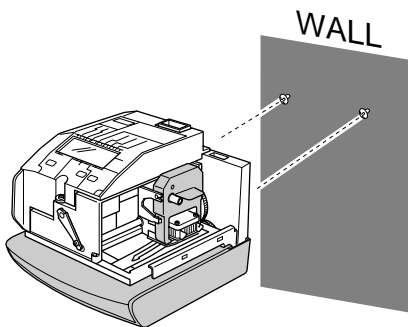

## Step 2

Unlock the key and remove the cover. And then hang it on the wall.

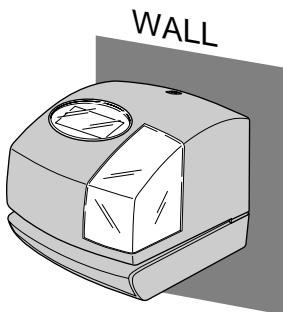

## Step 3

Replace the cover and lock.

# REPLACING THE RIBBON CASSETTE

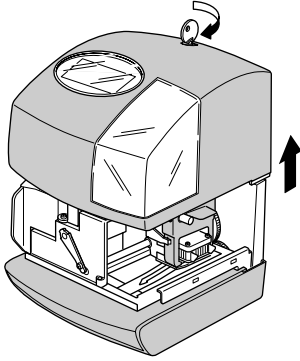

## Step 1

Unlock the key and remove the cover.

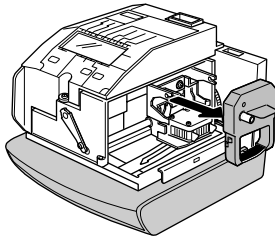

## Step 2

Pick up the cassette and remove it.

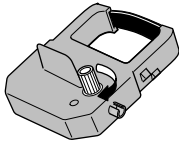

## Step 3

Turn the knob of the new cassette in the direction of the arrow to tighten the ribbon.

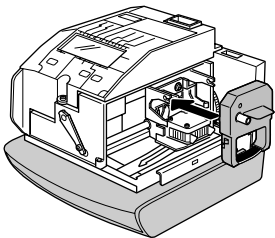

## Step 4

Place the cassette inside the time clock as shown in the figure. Keep on pushing in the cassette until the clasps at both sides catch and you hear a "pop" sound. If it is difficult to insert the cassette, try it while turning the knob.

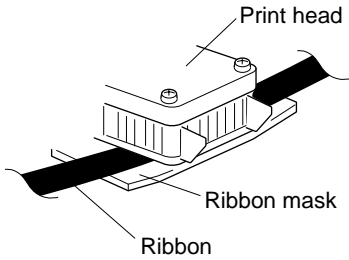

NOTICE: Install the cassette so that the ribbon is between the print head and the ribbon mask. Printing will not come out properly if the ribbon is placed behind the ribbon mask.

## Step 5

Turn the knob of the cassette in the direction of the arrow to tighten the ribbon.

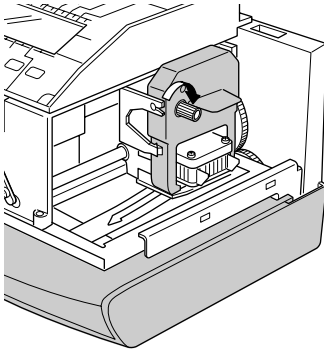

## Step 6

Replace the cover and lock.

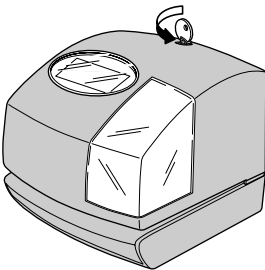

# TROUBLESHOOTING

## ERROR No. APPEARS

Refer to the following list for proper operation.

Error No.	Error contents	Action
E-00	CPU error	Contact the store from whom you bought the Time Clock, call Lathem Time directly at (800) 241-4990.
E-01	The remaining life of lithium battery for memory back-up is short.	
E-05	The card is not inserted in the clock properly.	Correctly insert the card.
E-30	Cannot print. The printer motor or home position sensor is not normal.	Make sure that the ribbon cassette is correctly inserted in place.
E-38	Cannot print. The print head motor or the sensor does not operate properly.	Press the push bar.
E-40	Incorrect password	Enter the correct password again.
E-41	D.S.T. setting mistake	Make sure the correct starting and ending date of daylight saving time and enter again.
E-49	Setting data you entered is not usable.	Refer to your owner's manual on the page related to the item you want to set and enter again correct setting data.

## OTHER FAILURES

- **The time clock does not operate.**

Ensure the AC adapter is properly plugged into the AC outlet.

- **The time clock does not print.**

Ensure the ribbon is installed correctly.

- **The card is jammed.**

Press the push bar and try to pull out the card at the same time.

# SPECIFICATIONS

Clock accuracy	Monthly accuracy $\pm 15$ sec. (at ordinary temperatures)
Calendar	Year up to 2099. Automatically adjusted to leap years, 31-day months and months with thirty or fewer days, and the days of the week.
Printing system	Dot matrix imprint
Power failure compensation	Five years of cumulative power failure hours after the date of shipment.
Operating environment:	Temperature: $-5^{\circ}$ to $45^{\circ}$ C, $+25^{\circ}$ to $113^{\circ}$ F Humidity: 20 to 80%, no condensation The unit operates normally at temperatures of $5^{\circ}$ C or below, but the print density, reaction of the liquid crystal display, and the number of prints at power failure are inferior to those at normal temperature operation.
Dimension	160(w) x 143(h) x 172(d) mm, 6.3"(w) x 5.63"(h) x 6.77"(d)
Weight	Approx. 1.4 kg. (2.0 kg with AC adapter)
Power consumption	Approx. 13W, AC120V $\pm$ 10%, 60Hz
Rating of AC adapter	I/P AC 120V/60Hz O/P AC 15.0V 1300mA

NOTICE: Use only the supplied AC adapter.

# MANUFACTURER'S WARRANTY

## Limited One-Year Warranty

Lathem warrants the model 1000E hardware product against defects in material and workmanship for a period of one year from date of original purchase. The conditions of this warranty and the extent of the responsibility of Lathem Time Corporation ("Lathem") under this warranty are listed below.

1. This warranty will become void when service performed by anyone other than an approved Lathem warranty service dealer results in damage to the product.
2. This warranty does not apply to any product which has been subject to abuse, neglect, or accident, or which has had the serial number altered or removed, or which has been connected, installed, adjusted, or repaired other than in accordance with instructions furnished by Lathem.
3. This warranty does not cover dealer labor cost for removing and reinstalling the machine for repair, or any expendable parts that are readily replaced due to normal use.
4. The sole responsibility of Lathem under this warranty shall be limited to repair of this product, or replacement thereof, at the sole discretion of Lathem.
5. If it becomes necessary to send the product or any defective part to Lathem or any authorized service dealer, the product must be shipped in its original carton or equivalent, fully insured with shipping charges prepaid.

Lathem will not assume any responsibility for any loss or damage incurred in shipping.

6. **WARRANTY DISCLAIMER: Limitation of Liability.** Except in only the limited express warranty set forth above, there are no expressed or implied warranties of merchantability and fitness for a particular purpose. In no event will Lathem be liable for any direct, special, or consequential damages arising out of or in connection with the delivery, use or inability to use, or performance of this product.
7. Proof of date of purchase is required for warranty service on this product.
8. This Warranty grants specific legal rights. Additional legal rights, which may vary by locale, may also apply.
9. Should any difficulties arise with the performance of this product during warranty, or with any Lathem authorized service centers, contact Lathem Time at the address below.

## **Lathem Time Corporation**

200 Selig Drive, SW, Atlanta, Georgia 30336

800-241-4990

[www.lathem.com](http://www.lathem.com)